

STANDARD FEATURES

ITEM NUMBER

- Solid one-piece cast marble
- Durable gel coat surface
- Pre-leveled-rests on subfloor
- Extremely sanitary
- Will not mold or mildew
- Easy to install
- Maintenance-free
- Manufactured in the U.S.A.
- Recommended: add Shower Pan Liners to protect pans during construction

- RI-CUST

TECHNICAL SPECIFICATIONS

MODEL	Custom Traditional, ADA Roll-In
PAN SIZE	Variable
MATERIAL	Cast Marble
FLOOR PATTERN	Traditional
FINISH	Matte, Textured, Non-Slip
BACKWALL	Variable - Up to 120" max on master
SIDE WALLS	Variable - Up to 60" max on master
DRAIN LOCATION	Must fit limitations of mold
CENTER OF DRAIN MEASURES	Variable - based on final pan size
DIMENSIONS	NOTE: Finished product dimensions may vary +/- 1/8" from drawings
DRAIN OPENING	3 1/4"
FRONT CURB	None. Floor will tile up to the entrance of the pan forming the ramp
RAMP	Provided by others
FLANGE	~4" on side and back walls - attached at factory
WEIGHT	Variable by size
CSI NUMBER	22 42 23

COLORS

ALMOND	7800
--------	------



CONTACT OUR SALES STAFF

M-F: 8:00 am - 5:00 pm Eastern

770-532-0451



WE'RE HERE TO HELP

Request a product sample, color sample or get a quote.

sales@minceymarble.com
samples@minceymarble.com

BONE	7670
CREAM	7400
IVORY	7300
WHITE	2250
LIGHT GRAY	7256
PUTTY	7000

SPECIAL NOTES

- Standards and Ratings:
 - CSA B45-5/IAPMO Z124-2011
 - MAS Certified Green. Compliant with ANSI/BIFMA X7.1 Standard
 - ANSI A137.1 (average rating of 0.65)
 - ANSI A326.3 (average rating of 0.72)
 - ANSI/NFSA B101.3 (average rating of 0.66)
- Suggested Drains:
 - Sioux Chief Mfg. model: 825-2P – PVC
 - Oatey part number: 42045 – PVC
 - Oatey part number: 42150 – Brass
 - Kohler model: K9132 – Stainless Steel
- NOTE: Finished product dimensions may vary +/- 1/8" from drawings
- NOTE: Drain is not included with pan

RI-CUST

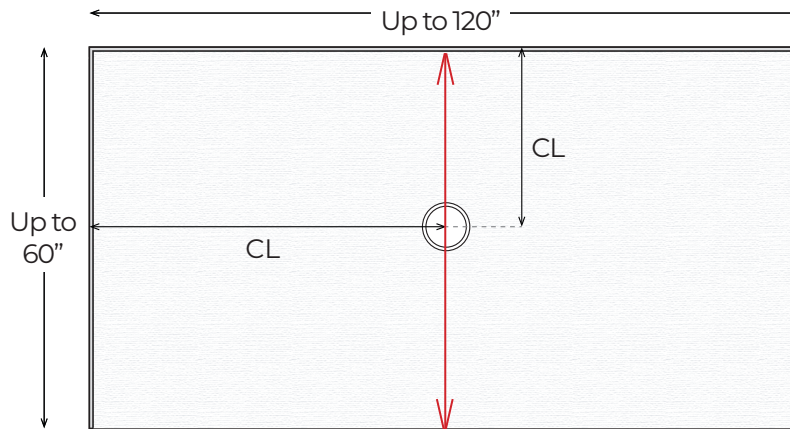

Finished product dimensions may vary by +/- 1/8" from drawings.

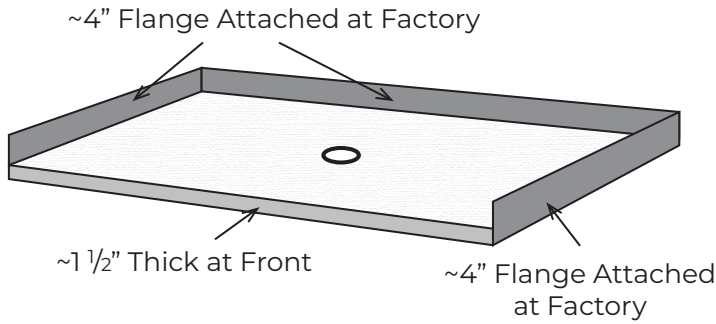

Drain Detail:

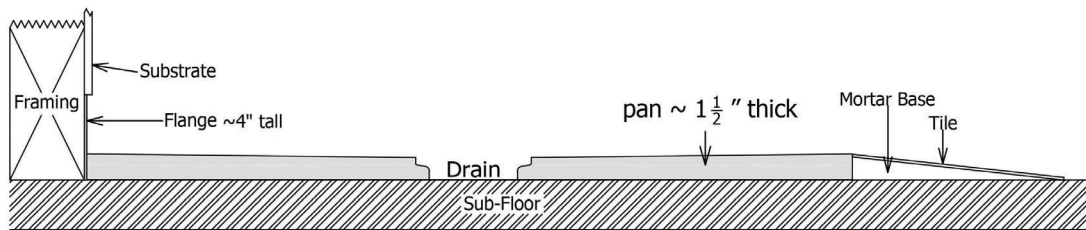
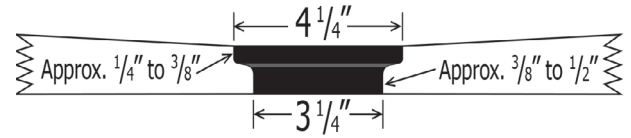

REV: 11.05.21