

TP-3838-C-SF

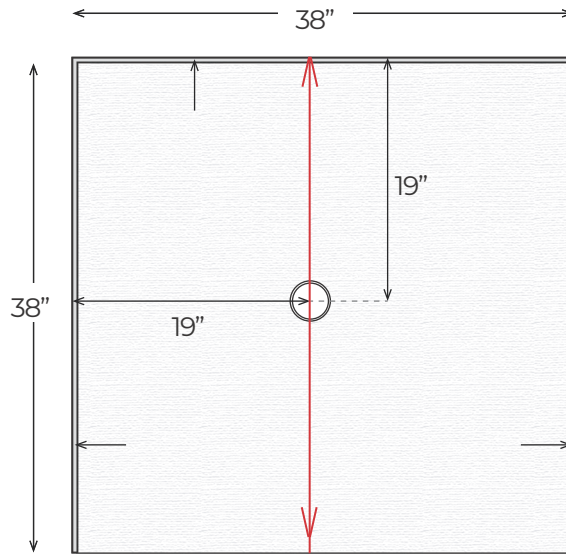

Finished product dimensions may vary by +/- 1/8" from drawings.

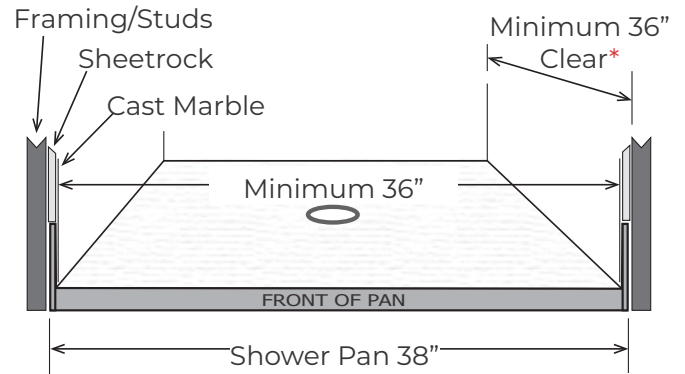
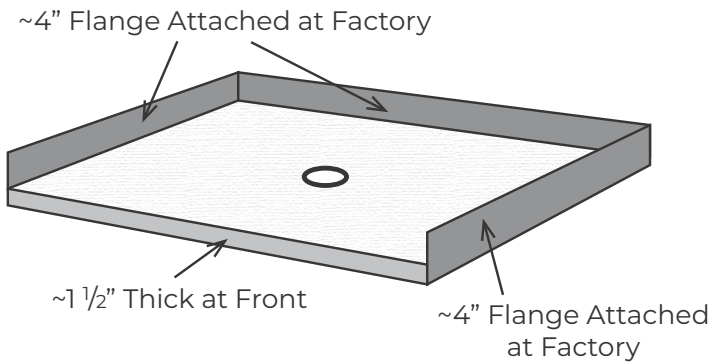

Note The ADA code requires the finished opening of a transfer pan to measure a minimum of 36" left to right and 36" front to back. The entrance must be flush with the entry floor, just like a roll-in pan.

Drain Detail:

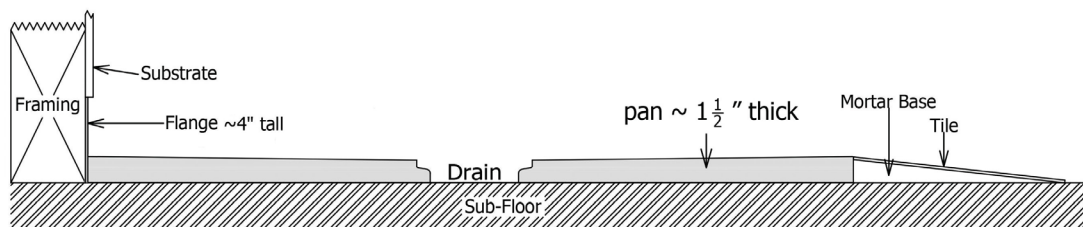
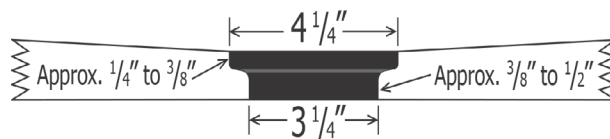

REV: 11.05.21