

SP-3660-C-SF

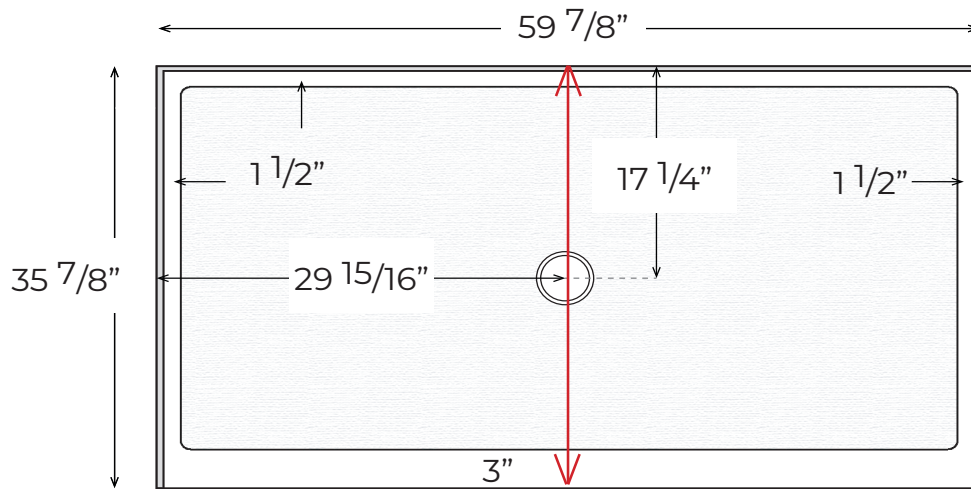

Finished product dimensions may vary by +/- 1/8" from drawings.

1" Flange Attached at Factory Back & Sides

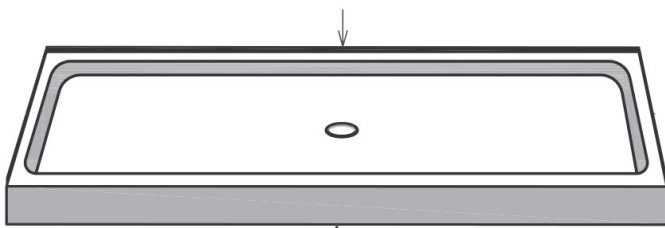

Integral 3" Curb

Drain Detail:

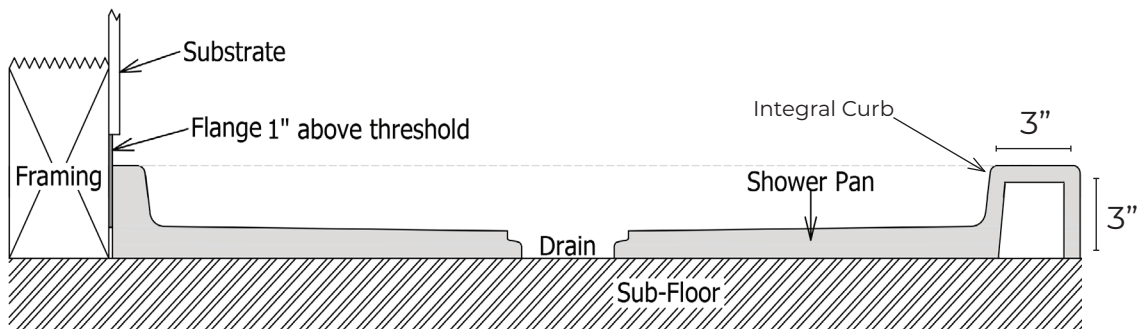
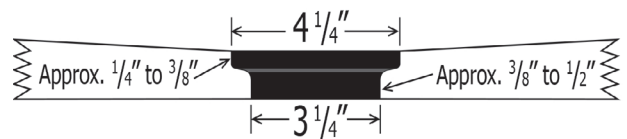

REV: 11.04.21